

ELEVATOR



Raising Performance to
New Heights



- MR Elevator • MRL Elevator • Hydraulic Elevator

All types of Elevator Servicing,
Installation, Upgrades & Maintenance



FITTECH

FITTECH ELEVATORS PVT. LTD.

About Us :

Fittech Elevators help Extend the lifetime of your elevators, escalators, and Travelator by providing best in class maintenance services.

Our philosophy of maintenance is simple you should not wait for something to break down. We don't believe in artificially reducing costs and only working on equipment when it fails. We believe that keeping up with elevator and Escalator preventative maintenance ensures equipment remains in service for as long as possible.

This saves our customers money over the long run and significantly extends the lifespan of their elevators and escalators. Our commitment to the highest level of preventative maintenance makes us one of the premier sources for commercial elevator and Escalator maintenance in the industry

More Than
750
Elevators Installed

Different Type of Elevator Technology



High
Performance

Machine Room System (MR)

FITTECH Elevators Provides "best in class" ride quality on every equipment installed.

Machine room passenger elevator is one of most popular product in both private and public sectors.

The Machine room is an area set aside for the elevator equipment such as controllers and mechanical unit.



Reduction in
Elevator Equipment
Area of
40%

Machine Roomless System (MRL)

The Machine room-less elevator is a great leap in technology. MRL elevator not only look fabulous in new constructions and major renovation projects but when compared to standard elevator equipment, it saves substantial construction space reducing building expenses and is upto 40% energy efficient. Its features include excellent reliability and durability, is oil free and operates silently.

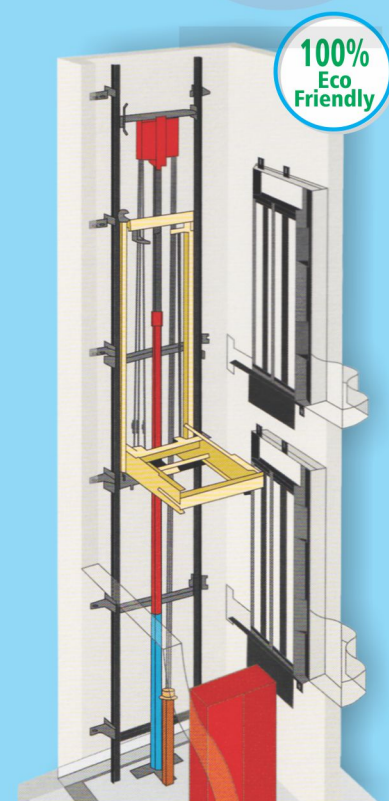

100%
Eco
Friendly

Hydraulic System (MRL)

Lift which are powered by a piston that travels inside a cylinder.

An electric motor pumps hydraulic oil into the cylinder to move the piston.

The piston smoothly lifts the elevator cab. Electrical valves control the release of the oil for a gentle descent.

Capsule Elevator



FITTECH

Combining Static and Dynamic Energy

Panoramic Elevator

We provide all types of capsule elevators having futuristic design to provide a cosmic zone experience to the passengers.

The design provide extremely silent operation. It is also reliable and economical with minimum maintenance.

- Attractive looks
- Unique features
- Transparent

Available Rated Speed : 1.0, / 1.5 / 2 MPS
 Max Travel Height : 66 M
 Available Rated Capacity : 408 to 1088 Kgs
 Max Passengers : 06 to 16 Passengers

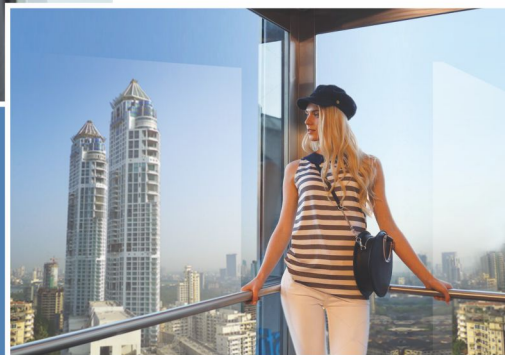

There is a variety of forms to meet different needs.

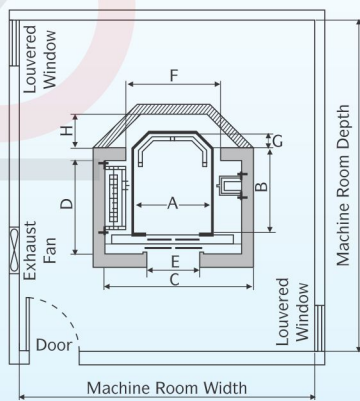
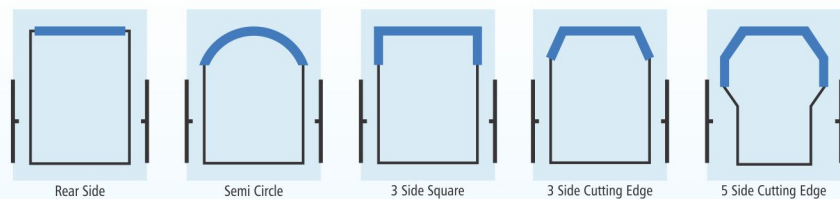

Geared & Gearless

Dimension for 3/5 Side Glass Panoramic Capsule Elevator

LOAD		ELEVATOR SHAFT		CAR PLATFORM		CAR INSIDE		ENTE RANCE	SPEED MPS	MACHINE ROOM		PIT DEPTH	OVER HEAD	CAR INSIDE SQ.MTR
Person	kg	W	D	W	D	W	D			W	D			
10	680	2100	1300	1150	1800	1090	1650	800	1.0/1.5	3250	4800	1600	4800	1.79
13	884	2400	1600	1450	1800	1390	1650	900	1.0/1.5	3550	5100	1800	5000	2.29
16	1088	2400	1600	1450	2100	1390	1950	900	1.0/1.5	3550	5100	1800	5000	2.71
20	1360	2400	1600	1450	2400	1390	2250	1000	1.0/1.5	3550	5100	1800	5200	3.12

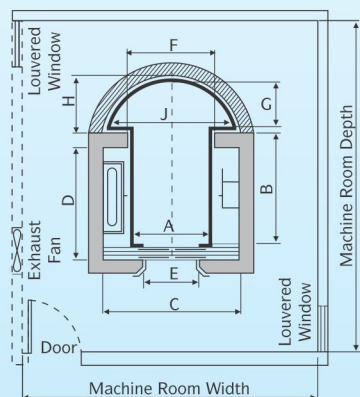

Geared & Gearless

Dimension for Round Glass Panoramic Capsule Elevator

LOAD		ELEVATOR SHAFT		CAR PLATFORM		CAR INSIDE		ENTE RANCE	SPEED MPS	MACHINE ROOM		PIT DEPTH	OVER HEAD	CAR INSIDE SQ.MTR
Person	kg	W	D	W	D	W	D			W	D			
10	680	2000	1300	950	1950	890	1800	800	1.0/1.5	3250	4700	1600	4800	1.79
13	884	2250	1400	1150	2200	1090	2050	900	1.0/1.5	3350	4950	1800	5000	2.29
15&16	1088	2500	1500	1400	2300	1340	2150	900	1.0/1.5	3450	5200	1800	5000	2.71
20	1360	2550	1600	1450	2500	1390	2350	1000	1.0/1.5	3550	5100	1800	5200	3.10

Passenger Elevator

When passengers ride your elevators you want them safe



Manual Door

Highly efficient passenger elevators using premier Raw Material. Particularly designed by our professionals these lifts are used for carrying passengers from one floor to another. These lifts are designed in different forms like powder coated or stainless steel with matt finished stainless steel by our professionals.

Available Rated Speed 0.63 / 1.0, / 1.5 / 2 MPS
 Max Travel Height 66 M
 Available Rated Capacity 272 to 1020 Kgs
 Max Passengers 04 to 15 Passengers

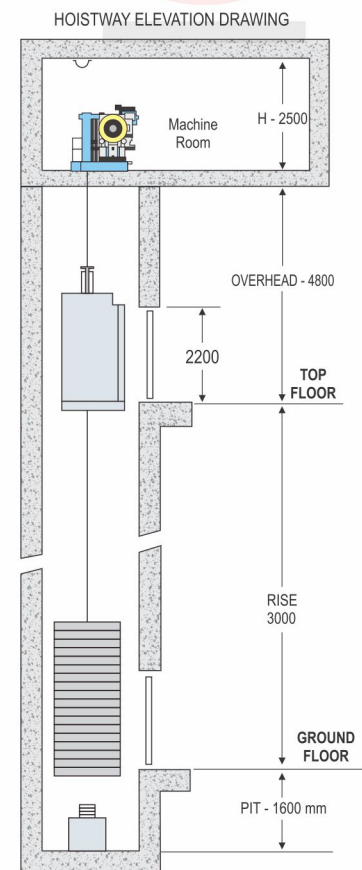
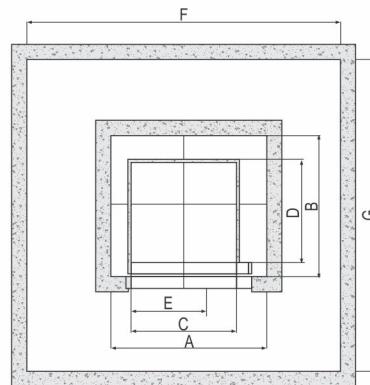

Application :



Apartment



Industrial Building



Offices



LOAD		LIFT WELL		CAR INSIDE		ENTRANCE	MACHINE ROOM			SPEED UP TO 1 m/s.	
Person	Weight	Width	Depth	Width	Depth		Width	Depth	Height	Pit	O.H.
IN KG.		A	B	C	D	E	F	G	H		
4	272	1300	1300	1100	700	700	2600	3200	2500	1500	4800
5	340	1400	1300	1100	850	700	2600	3350	2500	1500	4800
6	408	1500	1500	1100	1000	700	2600	3500	2500	1500	4800
8	544	1800	1800	1350	1300	800	2850	3800	2500	1500	4800
10	680	2300	2100	2000	1300	800	3500	3800	2500	1500	4800
13	884	2600	2300	2000	1300	900	3500	3800	2500	1500	4800
15	1020	2700	2400	2000	1300	900	3500	3800	2500	1500	4800

• All Dimension are in mm. • This is General Data, it may be changed without notice. • All hoist way walls should be minimum 230 mm brick or 150 mm R. C. C.

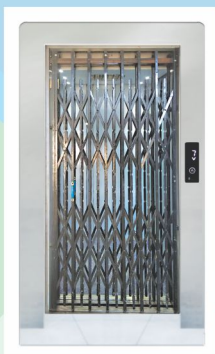

Manual Collapsible Door



Manual Imperforated Door



M.S. Powder Coated Frame Full Glass Swing Door



Manual Swing Door

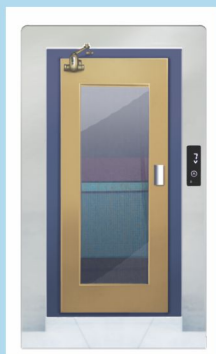

Full Glass Manual Swing Door



Manual Telescopic Door

Passenger Elevator



Available Rated Speed 0.63 / 1.0, / 1.5 / 2 MPS
 Max Travel Height 66 M
 Available Rated Capacity 272 to 1360 kgs.
 Max Person 04 to 20 Passengers



FITTECH

Automatic Door

FITTECH ELEVATORS has been engineered with full automatic doors. Fabricated with most advanced lift controls, appreciated for their high speed, smooth travel and perfect leveling different types of doors Center Opening, Telescopic Opening.

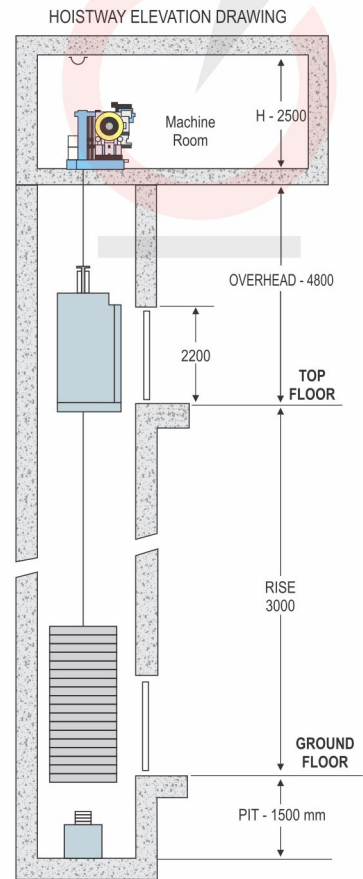
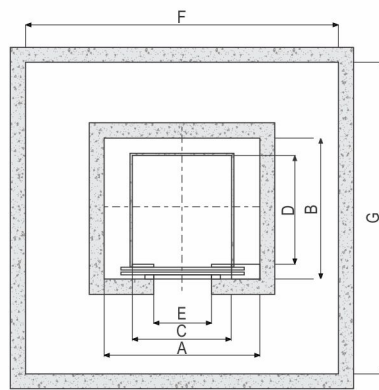

2-Panel Centre Opening Car Door Mechanism

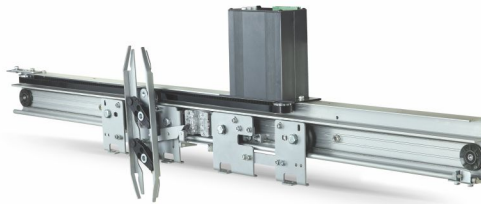

2-Panel Centre Opening Car Door Mechanism

LOAD		LIFT WELL		CAR INSIDE		ENTRANCE	MACHINE ROOM			SPEED UP TO 1 m/s.	
Person	Weight	Width	Depth	Width	Depth		Width	Depth	Height	Pit	O.H.
IN KG.		A	B	C	D	E	F	G	H		
4	272	1900	1300	1100	700	700	2900	3300	2500	1500	4800
6	408	1900	1700	1100	1000	700	2900	3700	2500	1500	4800
8	544	1900	1900	1300	1100	800	2900	3900	2500	1500	4800
10	680	1900	2100	1300	1350	800	2900	4100	2500	1500	4800
13	884	2500	1900	2000	1100	900	3500	3900	2500	1500	4800
16	1088	2500	2100	2000	1300	900	3500	4100	2500	1500	4800
20	1360	2500	2400	2000	1500	2000	3500	4400	2500	1500	4800

• All Dimension are in mm. • This is General Data, it may be changed without notice. • All hoist way walls should be minimum 230 mm brick or 150 mm R. C. C.

Multi-ray Entrance Protection System

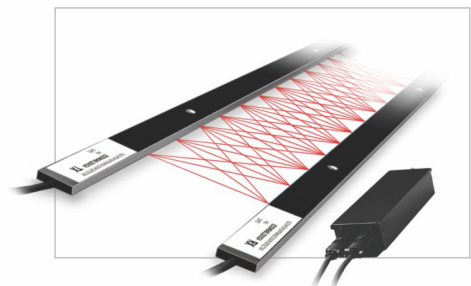

Center Opening Auto Door (Small Vision)



Hairline Finish Telescopic Auto Door

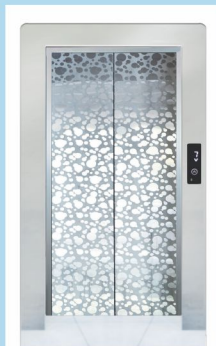

Center Opening Auto Door (Designer Finish)



Center Opening Auto Door (Four Panel)

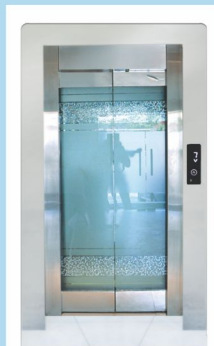

Glass Center Opening Auto Door (Full Vision)



Center Opening Auto Door (Big Vision)

Goods Elevator

www.fittechelevators.com

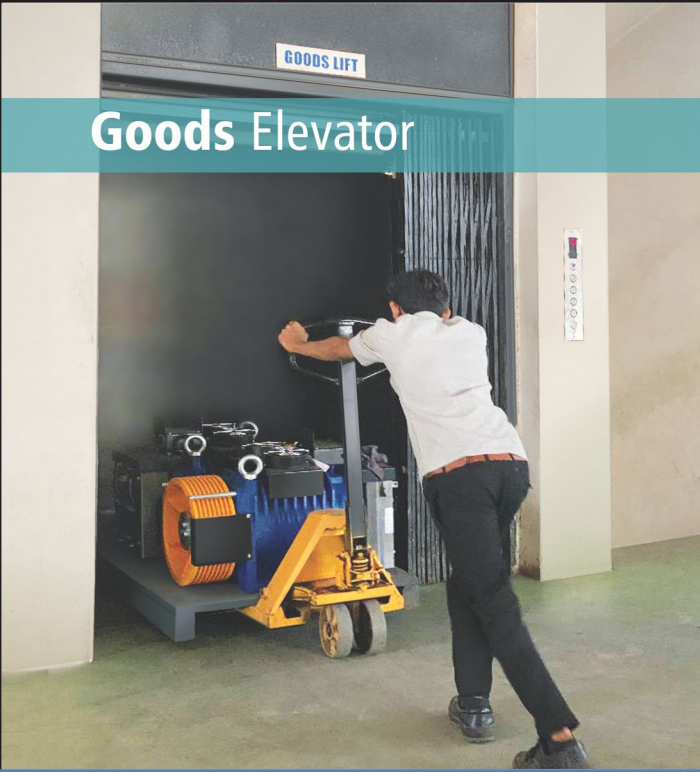

Available Rated Speed 0.50 / 1.00 / 1.50 MPS
 Max Travel Height 66 M
 Available Rated Capacity 500 to 4000 Kgs

Freight Elevator

For carrying various sized goods and equipment from one floor to another, we design and develop Goods Elevator. These elevators are designed with utmost precision and thus, ensure noiseless operation. Clients appreciate excellent load bearing capacity with slow speed and smooth running operation.



Accurate Leveling

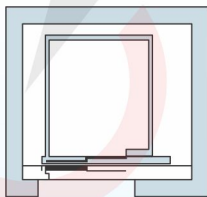
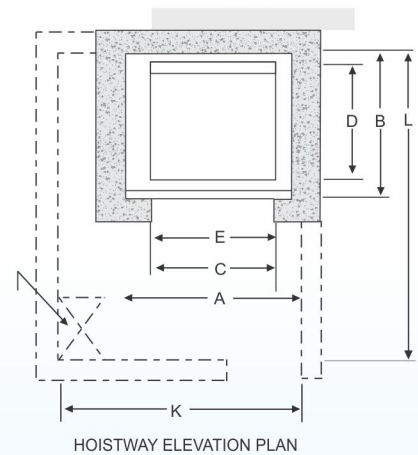

Single Way Door

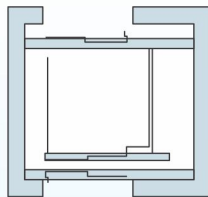

Double Way Door

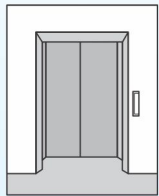

Two Panel Sliding Panel

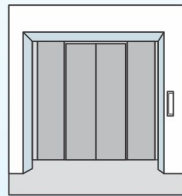

Center Opening & Double Folded



Large door width

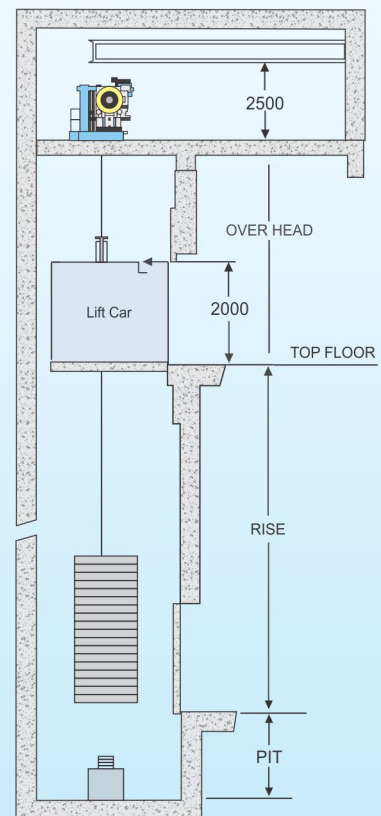

Majority used in manufacturing industry setups, our goods-cum-passenger lifts are able to carry bulky goods up to 5000kg.

Load	Lift Well		Car Inside		Entrance		Machine Room		UPTO 0.7 M / SEC.	
Weight	Width		Depth	Width	Depth	Width	Depth	Height	Pit	O.H.
IN KG	A	B	C	D	E	F	G	H	K	M
500	1900	1500	1100	1200	750	3000	3800	2500	1600	4800
1000	2300	2100	1400	1800	1000	3000	4000	2500	1600	4800
1500	2600	2300	1700	2000	1250	3200	4200	2500	1600	4800
2000	2600	2800	1700	2500	1500	3200	4200	2500	1600	4800
2500	2900	2800	2000	2500	1500	3500	4400	2500	1600	4800
3000	2900	3300	2000	3000	2000	3500	4500	2500	1600	4800
4000	3400	3300	2500	3000	2000	4000	4600	2500	1600	4800

All Dimension are in mm. This is General Data, without notice.

Hospital Elevator



Available Rated Speed 0.63 / 1 MPS
 Max Travel Height 66 M
 Available Rated Capacity 1020 to 1768 Kgs
 Max Passengers 15 to 26 Passengers



Stature Elevator

We offer Hospital Lifts for easy transportation of bulky equipment as well as patients. These are apt to meet the modern day hospital needs. These have sophisticated looks with high functionality. Hospital lifts are best to carry gurney, stretchers as well as wheel chairs.

- Intellectual Control
- Smooth and Comfortable
- Noise Reducing

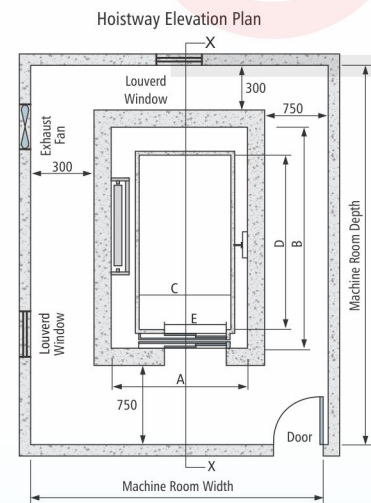

Providing Effortless Vertical Solution with Prior Safety



Special functions for the handicapped fulfill equal carrying in a harmonious space

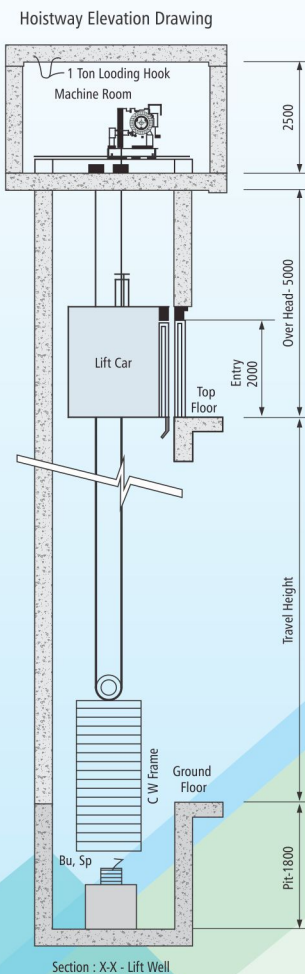

Automatic Centre Opening Door

Capacity	Shaft W	Shaft D	Car W	Car D	Shaft W	Shaft D	Car W	Car D	Entrance	
Person	KG.	A	B	C	D	A	B	C	D	E
15	1020	1900	3000	1000	2400	1700	3000	1000	2400	800
20	1360	2300	3000	1300	2400	1950	3000	1300	2400	900
26	1768	2600	3000	1600	2400	2100	3000	1600	2400	1000

Collapsible Door Can Be Provided If Required. Automatic Telescopic Door

Car Elevator

www.fittechelevators.com



Available Rated Speed 0.30 / 0.50 MPS
 Max Travel Height 30 M
 Available Rated Capacity 2500 / 3000 / 4000 Kgs

Automobile Elevator

Our car lifts are the perfect solution for hotels and the automobile industry, enabling you to transport your expensive cars vertically with utmost safety. Fitted with traction systems, our car lifts are able to handle heavy weight cars and come with an easy-to-use mechanism. The power consumed is low, which make our car lifts an ideal choice for the automobile sector.

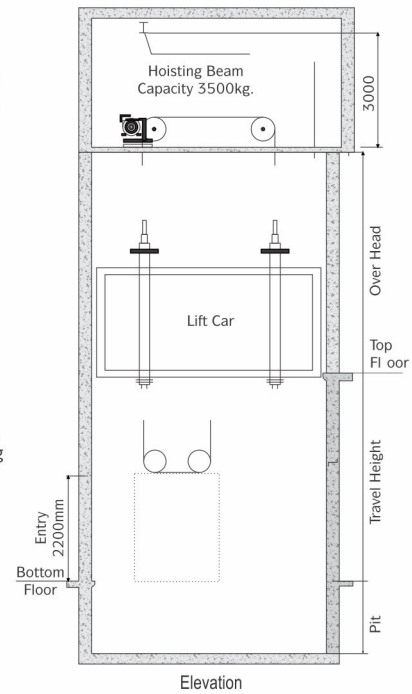
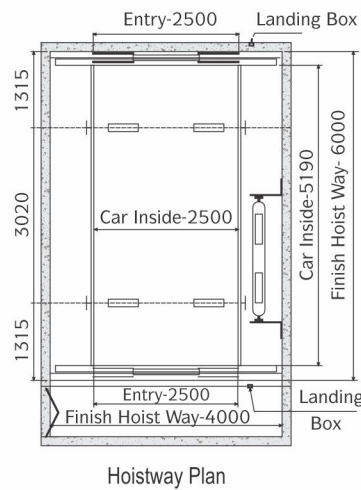

A New Level Parking Freedom



Description	Vertical Transportation for Cars/ LMVs
Segment	Industrial applications & Car Parks
Max. Travel (m)	100 (Solutions available for higher travel)
Max. Load (kg)	500 - 3000 Kg (Solutions available for higher capacities)
Max. Speed (m/s)	0.5 mps (Solutions available for other speeds)

Different Types of Car Parking Solution



Two Car Parking System



Electric Scissor Car Lift



Car Puzzle Parking

MRL Elevator



FITTECH



Machine Roomless Elevator

We are known for our effective variety of MRL Elevators, which do not, required any space to save and machine room. These products are manufactured under the guidance of our quality experts and have various qualities like high performance, light weighted, efficient, reduced motor size, tensile strength and long life.

Available Rated Speed 1.00 / 1.50 / 2 MPS
 Max Travel Height 66 M
 Available Rated Capacity 408 to 884 Kgs
 Max Passengers 06 to 13 Person



Compact Design



Energy Saving



Construction Cost Saving



Flexible to building design

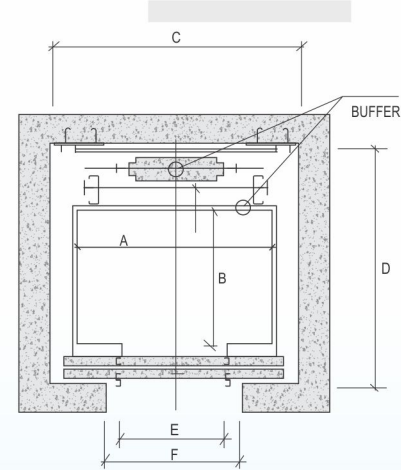

It saves 25% of Total Elevator Equipment Area.
 It Reduces 40% of Space Occupation

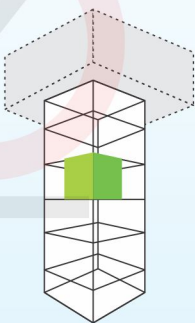

Machine Room of the Ordinary Elevator

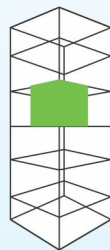

Machine Room Less Elevator

New generation permanent magnet synchronous gearless traction machine

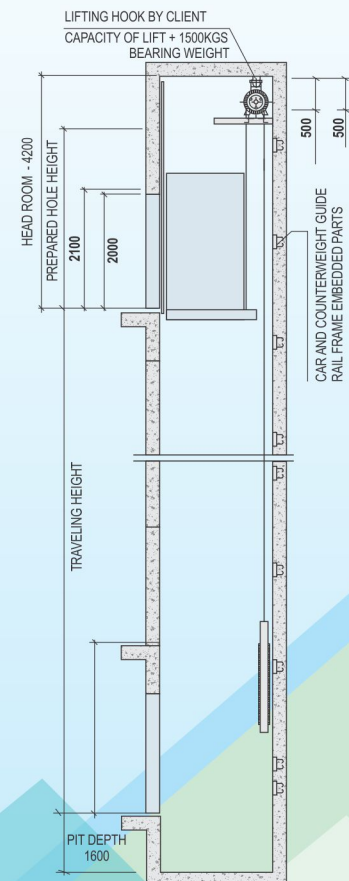

Construction Parameters

Capacity		Car Inside			Lift Well		Clear Entrance	Clear Opening At Landing
Person	KGS	A	B	C	D	E	F Auto Door	F Manual Telescopic
6	408	1200	900	1800	1400	700	780 / 2100	1450 / 2350
8	544	1300	1100	1900	1600	800	880 / 2100	1600 / 2350
10	680	1300	1300	1900	1800	800	880 / 2100	1600 / 2350
13	884	1600	1400	2200	1900	900	980 / 2100	1700 / 2350

- Above dimension may vary as per different types of and equipments.
- All dimensions are in mm.

Home Elevator

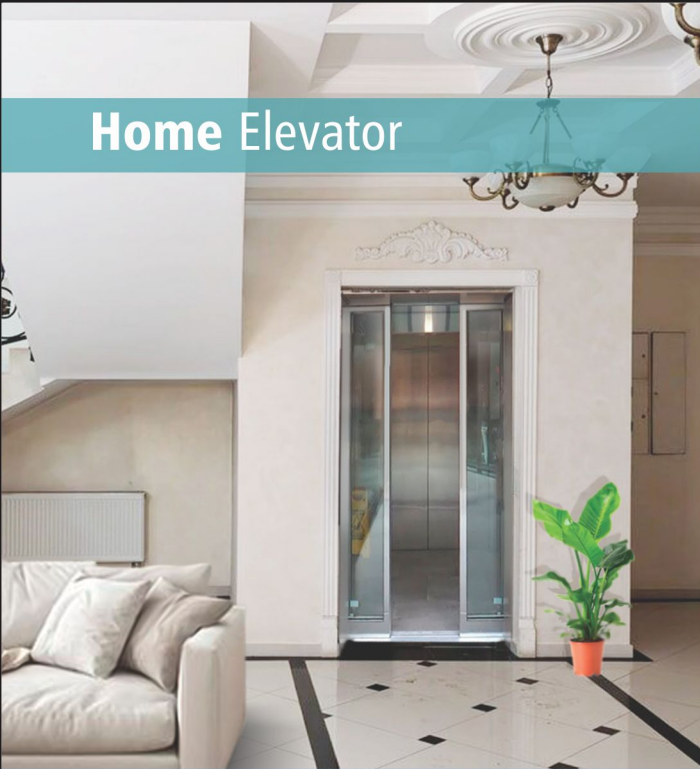

Available Rated Speed : 0.30 / 0.63 MPS
 Max Travel Height : 12 M
 Available Rated Capacity : 204 to 272 Kgs
 Max Passengers : 3 to 4 Passengers

Change Your Lifestyle with Best Home Lift

Bungalow Lift

Home elevator are designed to enhance the convenience at your residence, yet it is space saving, highly elegant and perfectly blends with contemporary architecture.

Balancing our customer demands for aesthetic ambience, technology integration & user satisfaction is what we do the best.

Various designing options for car & car top lightning can be selected as indicated.

40% Energy Saving



Mini Gearless Machine

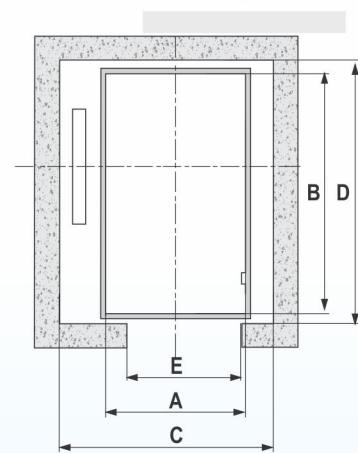

Door Operation	Load		Lift Well		Car Inside		Entrance	Speed	Pit	Over Head
	Persons	KGS	C	D	A	B				
Manual Door	3	204	1100	1200	810	700	700	0.3	550	3100
Manual Door	4	272	1300	1400	800	1200	700	0.3	550	3100
Auto Door	3	204	1250	1250	810	700	700	0.3	550	3100
Auto Door	4	272	1300	1600	850	1150	700	0.3	550	3100

Note : This Is Our Standard Data, If other Special Requirement Please Contact us.

High Car Ceiling Height : 2100mm

Electric Fan (Option)

LED Down Light Type (CE-EDB-C30)

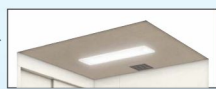
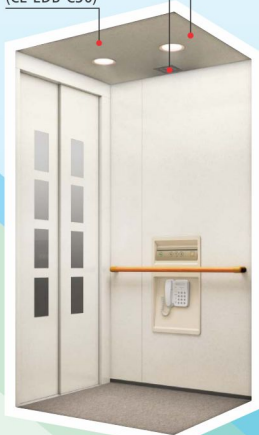

LED Rectangle Cover Light type (CE-EDB-A30)

High Entrance Height 2000mm



Entrance
 • Doors / Frame : Coated steel plate
 • Windows : Gray smoked plastics

Car Operating Panel



Landing Operating Panel



HOISTWAY ELEVATION PLAN

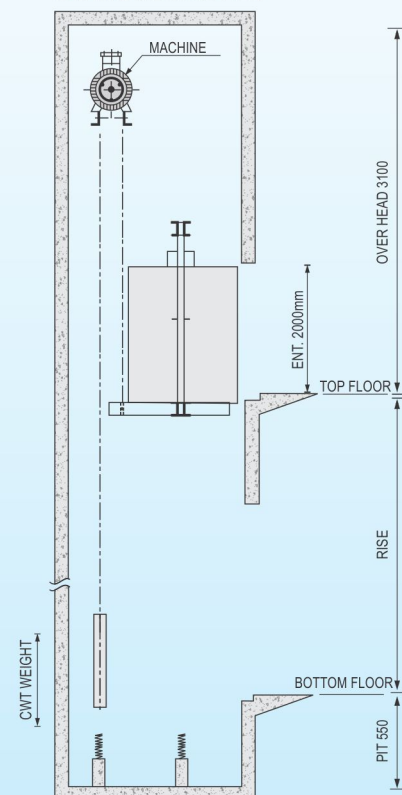

Hydraulic Elevator

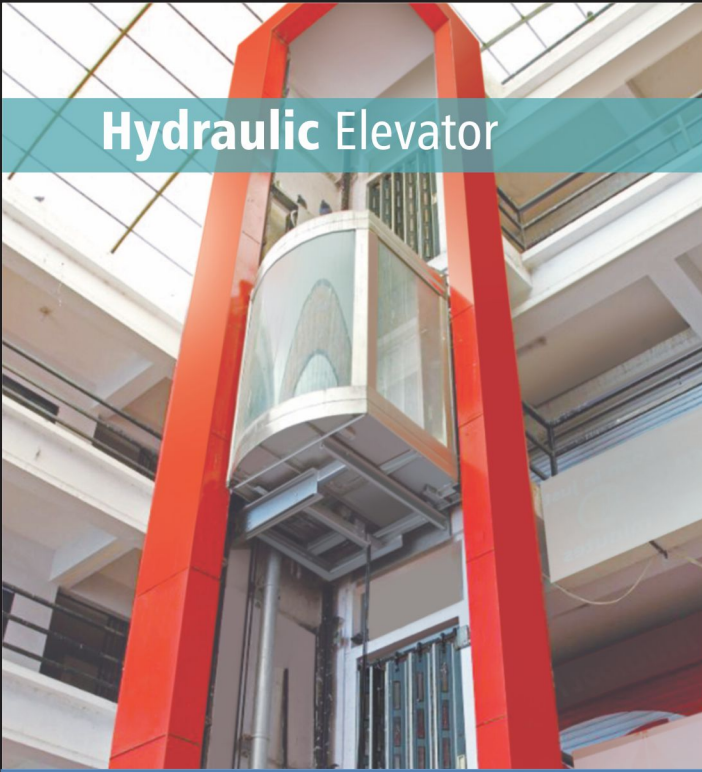

FITTECH

For Low Rise

We are one of the renowned elevators that have gained wide appreciation for operational excellence. These hydraulic elevators are precision engineered using advanced technology to offer best performance. They are compact in size and includes trolley mounted steel frame, hand pumps, top platform, hydraulic cylinders and scissors kind of steel bracing. Also, they can carry load holding at any height as a safety attribute to avoid any accidental slide down of the platform.

Available Rated Speed **0.30 MPS**
 Max Travel Height **30 M**
 Available Rated Capacity **225 / 1800 Kgs**
 Max Passengers **03 / 24 Passengers**

Features

- ▶ Wide load carrying capacity
- ▶ Simple, robust design.
- ▶ Minimum overall height.
- ▶ Controlled peak deceleration.

Benefits

- ▶ Required low overhead & low pit.
- ▶ Simple structure requirement.
- ▶ Quick to install.



Direct Central Acting

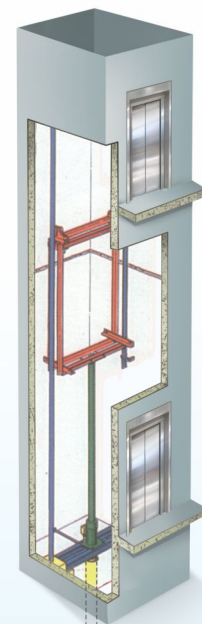

Indirect Side Acting 2:1

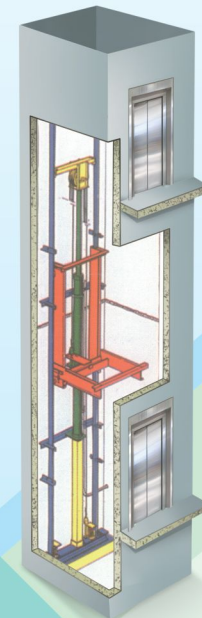

HOLE TYPE ACTING

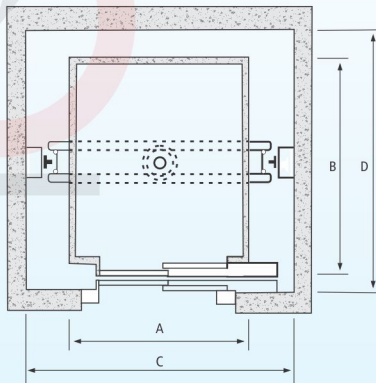

It is a directly acting suspension with a simple or split piston. It is the simplest solution of suspension for any load.

Persons	Capacity	Car-W	Car-D	Shaft-W	Shaft-D
	Kg	(A)	(B)	(C)	(D)
3	225	800	1100	1500	1500
4	300	850	1050	1550	1550
5	375	1000	1200	1600	1600
6	450	1100	1250	1700	1700
8	600	1200	1500	1700	1800
10	750	1200	1700	1700	2000
12	900	1300	1800	1900	2100
15	1125	1300	2200	2000	2500
20	1500	1400	2500	2100	2800
24	1800	1500	2500	2200	2800

ROPE TYPE - Single Cylinder

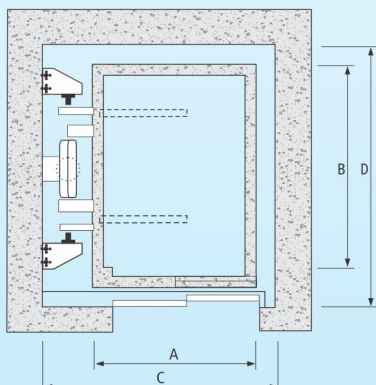

It is a single side indirectly acting suspension with wire ropes having one piston for regular loads.

Persons	Capacity	Car-W	Car-D	Shaft-W	Shaft-D
	Kg	(A)	(B)	(C)	(D)
3	225	800	900	1300	1300
4	300	850	1050	1350	1450
5	375	1000	1100	1500	1500
6	450	1100	1150	1600	1550
8	600	1100	1400	1600	1800
10	750	1200	1550	1700	1950
12	900	1300	1650	1800	2050
15	1125	1300	2000	1800	2400
20	1600	1400	2400	1900	2800



Cabin Designs

Create the look and feel you like. Combine colors, materials, lighting, mirrors, handrails and fixtures to achieve the ambiance that fits both your ideas and your building. Choose from one of our four interior design lines or design the whole car to your own taste.



Beautifully arched panel with shaded gradation



M.S. Powder Coating Cabin with Middle S.S. Hairline Sp. For Stature Cabin



S.S. Hairline Finish with S.S. Mirror Strip Cabin



S.S. Designer Cabin



M.S. Powder Coated With Middle Three Side S.S. Mirror Cabin



S.S. Hairline Finish Cabin



Rose Gold Designer Cabin



Gold Finish Designer Cabin

Capsule Elevator Cabin



Square Full Glass Cabin



One Side Glass Cabin



Round Carved Glass Cabin



Three Side Designer Glass Cabin

PVC Flooring Designs



F01



F02

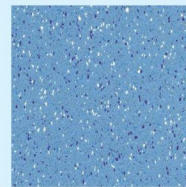

F03



F04

Ceiling



C01



C02



C03



C04



C05



C06



COP & LOP

Car Operating Panel & Landing Operation Panel



FE-L01



FE-L02



FE-L03

FE-C01

FE-C02

FE-C03

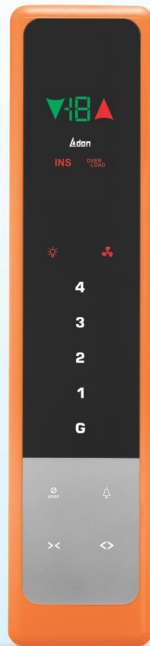

FE-L04



FE-L05



FE-L06

FE-C04

FE-C05

FE-C06

Display



A01D

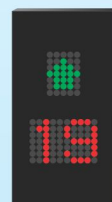

A02D



A03D



A04D



A05D

Gearless Machine Unit



Green Installment Saving
Environment Friendly

40%
Power Saving

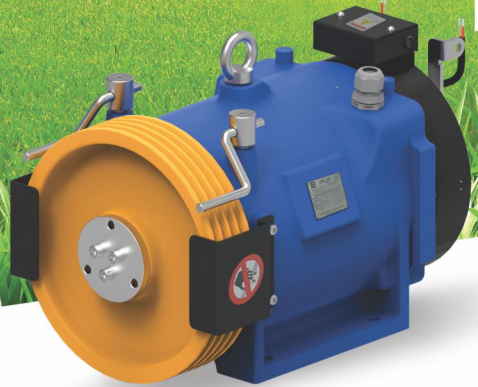

Gearless Traction Machine



I-127 Gearless Machine

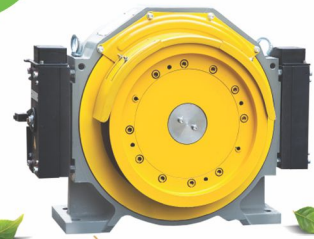

Gearless Machine

Geared Machine Unit

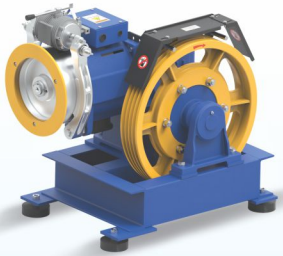

Traction Geared Machine

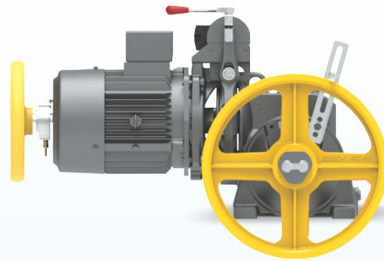

M67 Geared Traction Machine

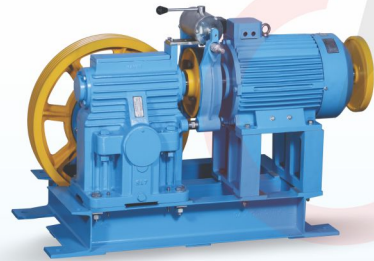

Upper Traction M/c.

Controler Panel

The safe and More
Energy-Saving
Integrated control

VVVF Drive



Traction MR Geared Controller



Microprocessor with
Integrated Controller



Automatic Rescue Device



MRL Control Panel



We are Technically
Associated with



FITTECH

FITTECH ELEVATORS PVT. LTD.

Office :

No. 1015, 10th Floor,
Roots Tower,
Distt. Centre Laxmi Nagar,
Delhi - 100092

Mobile : +91-8847271606

Land Line : 0161-5047145

Email : info@fittechelevators.com

Website : www.fittechelevators.com

Office :

Plot No- B-14/2674/2626/1,
Oppo Sanjeev Bakery,
Near Mini Rose Garden,
Ajit Nagar, Ludhiana-141008

